

1. CHECK POST SHAPE

2 TAPERED POST? YES/ NO (Please Circle)

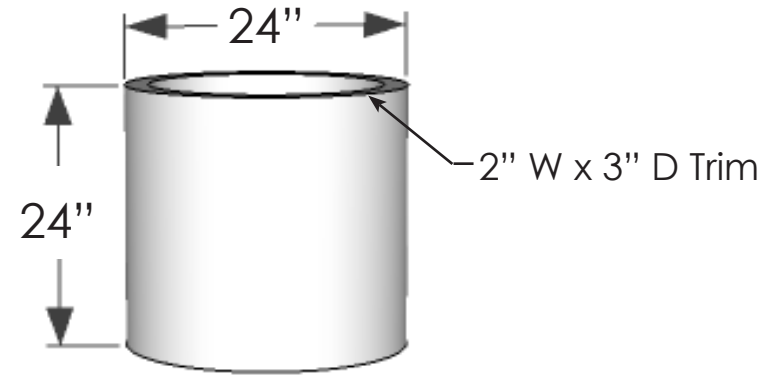
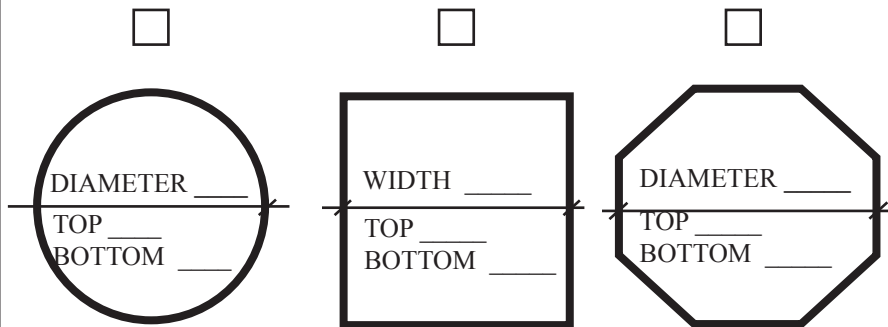

PERSPECTIVE VIEW

General Notes:

1. Locate drainage holes next to pads
 2. If no drain holes are requested it is assumed proper drainage will be added in the field
- Drainage: Yes ___ No ___

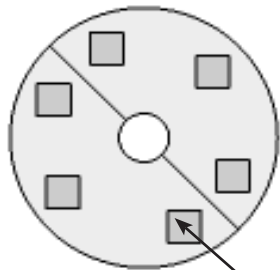

(6) Pads, 4"x4"x1/8"thk.
Offset 1" from edges.

BOTTOM VIEW

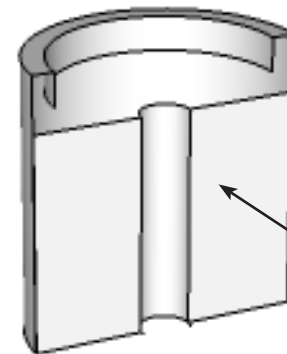

Made in two pieces to be assembled on site.
Bolt through Center Dividers to attach

HALF PLANTER VIEW

Date:
Scale: NTS
DB: GGG
CB:
Rep:
Order#:

Content: Modern Round Fiberglass Post Planter
PN: F1-POS-R2424
Color/Finish:
Customer Approval:

Design by Planters Unlimited
All visual representations and designs are the intellectual property of Planters Unlimited and protected under copyright law. Any duplication of this design is in direct violation of the law and will result in legal action.
© Copyright 2008-2016



**PLANTERS
UNLIMITED**
T:888-320-0626 F:760-598-9888