

1. CHECK POST SHAPE

2. TAPERED POST? YES / NO (Please Circle)

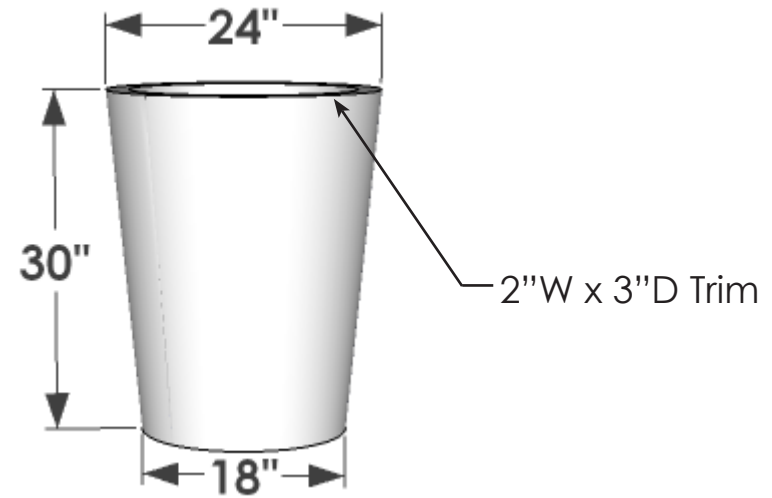
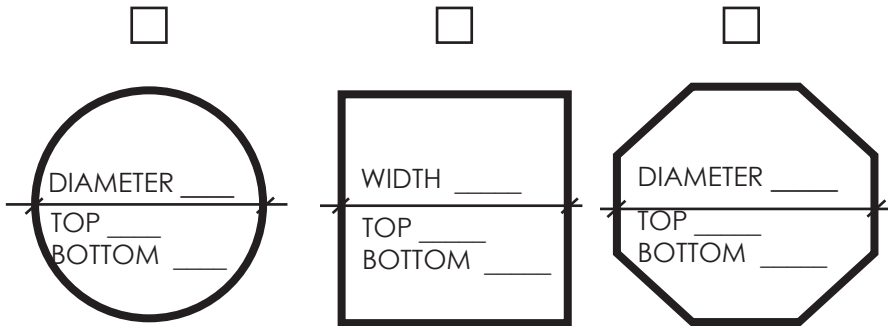

PERSPECTIVE VIEW

General Note:

If no drain holes are requested it is assumed proper drainage will be added in the field

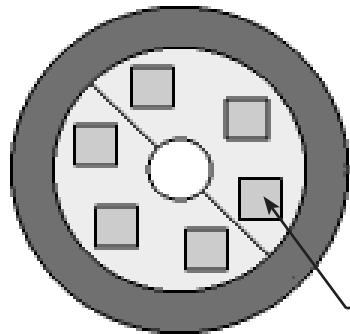

BOTTOM VIEW

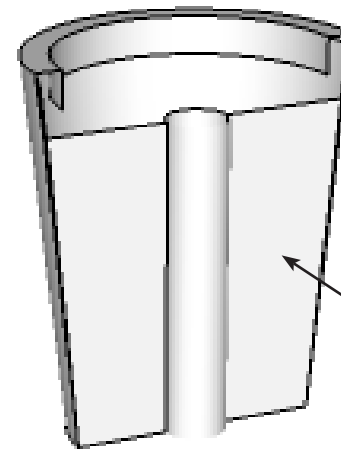

HALF PLANTER VIEW

Date:
Scale: NTS
DB: RMA
CB:
Rep:
Order#:

Content: Contempo Round Fiberglass Post Planters
PN: F1-POS-TR2430
Color/Finish:
Customer Approval:

Design by Planters Unlimited
All visual representations and designs are the intellectual property of Planters Unlimited and protected under copyright law. Any duplication of this design is in direct violation of the law and will result in legal action.
© Copyright 2008-2016



T:888-320-0626

F:760-598-9888