

PERSPECTIVE VIEW

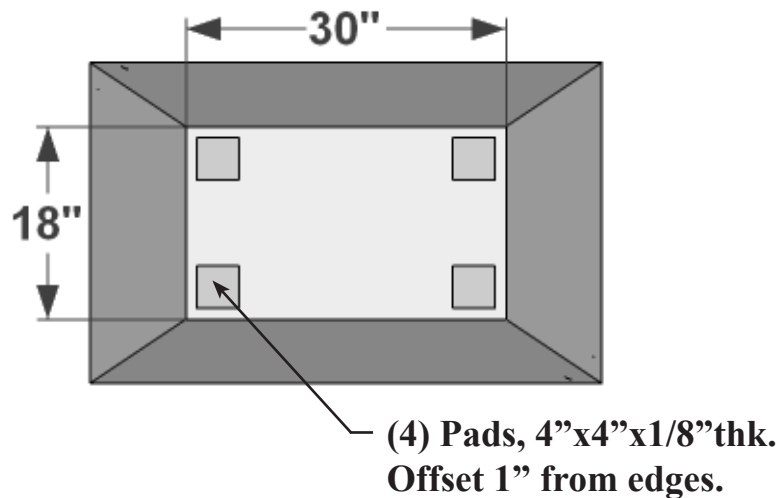

BOTTOM VIEW

**General Notes:**

1. Locate drainage holes next to pads
2. If no drain holes are requested it is assumed proper drainage will be added in the field

**Drainage: Yes \_\_\_ No \_\_\_**

Date:  
Scale: NTS  
DB: GGG  
CB:  
Rep:  
Order#:

Content: Modern Tapered Rectangular Fiberglass Planter  
PN: F1-MOD-TREC483024  
Color/Finish:  
Customer Approval: \_\_\_\_\_

Design by Planters Unlimited  
All visual representations and designs are the intellectual property of Planters Unlimited and protected under copyright law. Any duplication of this design is in direct violation of the law and will result in legal action. ©Copyright 2008-2016



T:888-320-0626 F:760-598-9888