

PERSPECTIVE VIEW

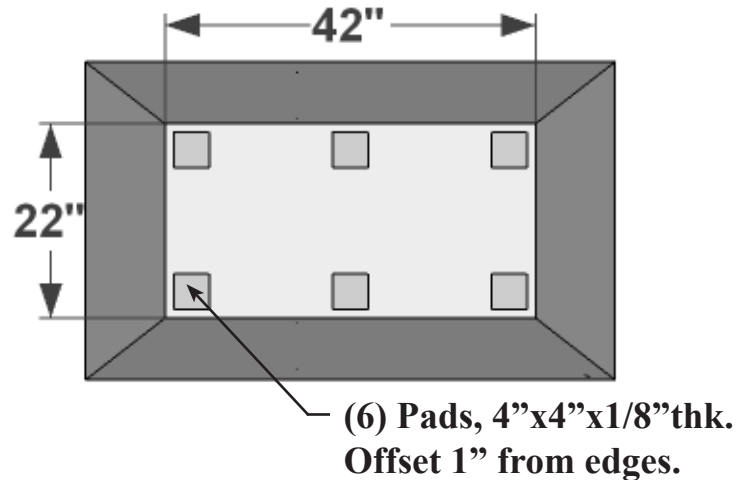

BOTTOM VIEW

General Notes:

1. Locate drainage holes next to pads
2. If no drain holes are requested it is assumed proper drainage will be added in the field

Drainage: Yes ___ No ___

Date:
Scale: NTS
DB: GGG
CB:
Rep:
Order#:

Content: Modern Tapered Rectangular Fiberglass Planter
PN: F1-MOD-TREC603636
Color/Finish:
Customer Approval: _____

Design by Planters Unlimited
All visual representations and designs are the intellectual property of Planters Unlimited and protected under copyright law. Any duplication of this design is in direct violation of the law and will result in legal action. ©Copyright 2008-2016



T:888-320-0626 F:760-598-9888