

PERSPECTIVE VIEW

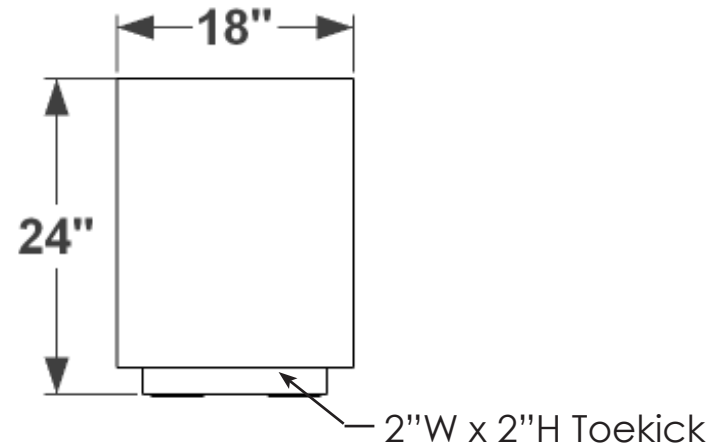

ELEVATION VIEW

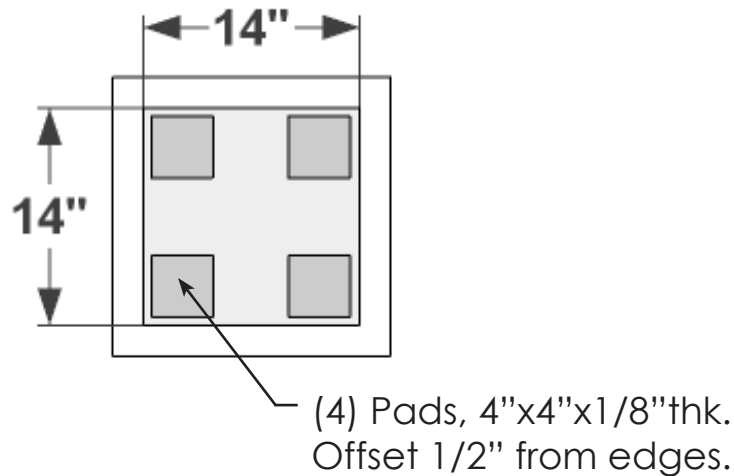

BOTTOM VIEW

General Notes:

1. Locate drainage holes next to pads
 2. If no drain holes are requested it is assumed proper drainage will be added in the field
- Drainage: Yes___ No___

Date:
Scale: NTS
DB: GGG
CB:
Rep:
Order#:

Content: Marek Square Fiberglass Planter
PN: F1-MAR-S1824
Color/Finish:
Customer Approval:

Design by Planters Unlimited
All visual representations and designs are the intellectual property of Planters Unlimited and protected under copyright law. Any duplication of this design is in direct violation of the law and will result in legal action.
© Copyright 2008-2016



**PLANTERS
UNLIMITED**
T:888-320-0626 F:760-598-9888