

**General Notes:**

- 1. Do you want our Standard Drainage Holes? (1/2" dia. holes) Yes: \_\_\_ No: \_\_\_
- 2. If no drain holes are requested it is assumed proper drainage will be added in the field.

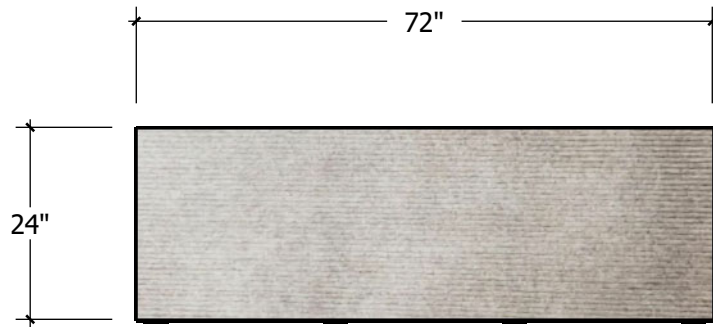

**FRONT VIEW**

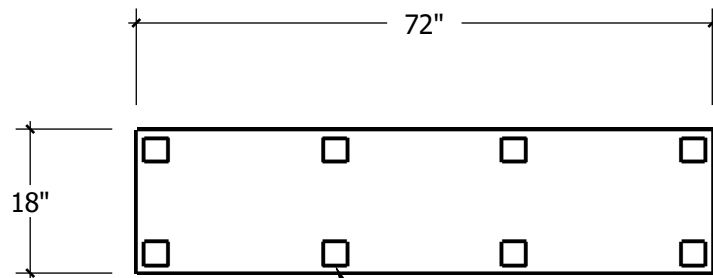

(8) Pads, 3" x 3" x 1/8 Thk  
Offset 1" from edges.

**BOTTOM VIEW**

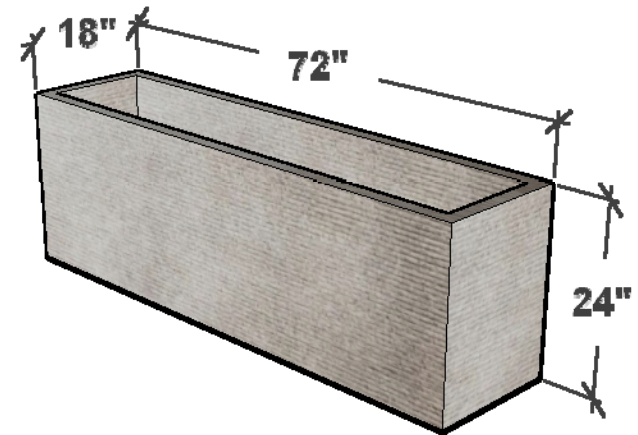

**PERSPECTIVE VIEW**

Date: 03/2021  
Scale: NTS  
DB: IG  
Rep:  
Order#:

Content: Verso Fiberstone Planter - 72" x 18" x 24"h

PN: C19-VER-REC721824-FS

Color/Finish:

Customer Approval: \_\_\_\_\_

Design by Planters Unlimited  
All visual representations and designs  
are the intellectual property of Planters  
Unlimited an protected under Copyright  
law. Any duplication of this design is in  
direct violation of the law and will resul  
tin legal action.

© Copyright 2008-2019

